

User's Manual

Artist

Power Amplifier



Important Precautions



This symbol is to remind the operator to strictly follow the instructions in the operation.



This symbol is to remind the operator that there is uninsulated dangerous voltage in the equipment, which may cause electric shock.

- 1 Save the carton and packing materials even if the equipment is arrived in good condition. Should you ever need to ship the device (back to the factory), you can only use the original manufacturer's packaging.
 - 2 Make sure to read all documentation carefully before operating the equipment and keep the documentation for future reference.
 - 3 Follow all instructions printed on unit chassis for proper operation.
 - 4 Do not spill water or other liquids into or on the unit, or operate the unit in a liquid environment.
 - 5 Make sure input power conform to the power requirements listed on the rear panel of the unit.
 - 6 Do not turn on the unit if the electrical power cord is frayed or broken. The power supply cords should be routed so that they are not likely to be walked on or pinched by items placed upon, paying particular attention to cords and plugs, convenience receptacles, and the point where they exit from the appliance.
 - 7 Always operate the unit under the AC ground wire connected to the electrical system. Precautions must be taken so that the means of grounding of a piece of equipment is not defeated.
 - 8 Mains voltage must be correct and same as that printed on the rear panel of the unit. Damage caused by connection to improper AC voltage is not covered by any warranty.
 - 9 Have gain controls on amplifiers turned down during power-up to prevent speaker from damaging if there are high signal levels at the inputs.
 - 10 Power down and disconnect units from mains voltage before making connections.
 - 11 Never hold a power switch in the "ON" position if it won't stay there itself.
 - 12 Do not use the unit near stoves, heat registers, radiators, or other heat producing devices.
 - 13 Do not block fan intake or exhaust ports. Do not operate equipment on a surface or in an environment which may impede the normal flow of air around the unit, such as a bed, rug, weather sheet, carpet, or completely enclosed rack. If the unit is used in an extremely dusty or smoky environment, the unit should be periodically "blown free" of foreign matter.
 - 14 Do not remove the cover. Removing the cover will expose you to potentially dangerous voltages. There are no user serviceable parts inside.
 - 15 Connecting amplifier outputs to oscilloscopes or other test equipment while the amplifier is in bridged mode may damage both the amplifier and test equipment.
 - 16 Do not drive the inputs with a signal level greater than that required to drive equipment to full output.
 - 17 Do not connect the inputs / outputs of amplifier or consoles to any other voltage source, such as a battery, mains source, or power supply, regardless of whether the amplifier or console is turned on or off.
 - 18 Do not run the output of any amplifier channel back into another channel's input. Do not parallel or series-connect an amplifier output with any other amplifier output. AUDIOCENTER is not responsible for damage to loudspeakers for any reason.
 - 19 Do not ground any red ("hot") terminal. Never connect a "hot" (red) output to ground or to another "hot" (red) output.
 - 20 Non-use periods: The power cord of equipment should be unplugged from the outlet when left unused for a long period of time.
 - 21 Service information: Equipment should be serviced by qualified service personnel when:
 - A The power supply cord or the plug has been damaged;
 - B Objects have fallen, or liquid has been spilled into the equipment;
 - C The equipment has been exposed to rain;
 - D The equipment does not appear to operate normally, or exhibits a marked change in performance;
 - E The equipment has been dropped, or the enclosure damaged.
 - 22 To obtain service, please contact your nearest AUDIOCENTER service centre, distributor or dealer.
-

Table of Contents

Introduction	2
Unpacking	2
Installation	2
User Precautions	2
Maintenance	2
User Responsibility	3
Artist T2.4V/T4.4V	
Front Panel	3
Rear & Side Panel	3
Introduction of Front & Rear Panel Function	4
Mode Selection	5
Connection Mode	7
Artist T4800/T8800	
Front Panel	8
Rear & Side Panel	8
Introduction of Front & Rear Panel Function	9
Mode Selection	10
Connection Mode	11
Artist T4.8V/T8.8V	
Front Panel	12
Rear & Side Panel	12
Introduction of Front & Rear Panel Function	13
Mode Selection	14
Connection Mode	15
Operation	16
Specifications	Appendix A

Introduction

Congratulations on your purchase of a new Artist professional power amplifier, and thank you for your support in AUDIOCENTER products. You are among the growing number of audio professionals who have made AUDIOCENTER one of the world's leading suppliers of professional and commercial/industrial audio systems.

For your safety, please read the Important Precautions before installing and operating the power amplifier. Artist amplifier is a switching-power-supply and Class-D power amplifier, not only adopts a unique modular organizational structure, but also has a novel and beautiful appearance design. The amplifier can be used with other AUDIOCENTER Artist Commercial Audio Solution products (including processors and loudspeakers), or with loudspeaker system of other brands. In order to maintain strict quality assurance standards, all Artist-Pro amplifiers are built in AUDIOCENTER's state-of-the-art manufacturing faculty. Internal components are the finest available, and key assemblies are pre-tested before final assembly. Finally, each power amplifier is "burned in" and thoroughly tested (using audio precision test equipment) before shipping. In addition, all Artist-Pro amplifiers incorporate AUDIOCENTER's exclusive Tour Class protection features to safeguard both internal and connected loudspeakers. This proven combination of advanced design, quality structure and comprehensive circuit protection is your guarantee of fail-safe reliability. You can rest assured for its consistent and stable performance even when your Artist-Pro amplifier is subject to punishing extremes in the most demanding fixed or mobile sound reinforcement applications.

Unpacking

Please check the power amplifier carefully after unpacking. If you find any damage, you can notify your supplier/dealer immediately. Only the shipper can claim compensation from the carrier for damage caused during transportation. Be sure to keep carton and all other packing materials for carrier to double check. If you want to send the unit back to AUDIOCENTER Distributor in china or AUDIOCENTER authorized service center, you need to use the manufacturer's original packaging.

Installation

Artist T2.4V Artist T4.4V have 1U height and half 19" rack width, could be installed in 19" rack with the built-in accessory. Artist T4800, Artist T8800, Artist T4.8V, Artist T8.8V have 2U height, there are four mounting holes in the front panel, could be installed in 19" rack.

User Precautions

Protection for Speaker

All speakers have limit values for electrical, temperature, and physical characteristics. These characteristics must be strictly observed to avoid damage to the speakers. The driver may be damaged if use too-high low-frequency signal level to drive tweeters or severely clip signals or apply DC voltage to the speakers. All power amplifiers of Artist-Pro Commercial Audio System Solution can automatically protect the speakers under DC voltage and severely clipped signals.

Mid-to-high-tweeter units are particularly susceptible to damage due to the application of excessive power, clipped level signals or level signals below their passband. Make sure that the speakers are properly connected to the frequency-divided signals when using electronic crossovers.

The power amplifier's clipping point is its maximum peak output power. At maximum peak output power, AUDIOCENTER Artist Commercial Audio System Solution power amplifiers will deliver more than many speakers can safely handle. To ensure that the speakers never receive excessive power, use a properly adjustable external limiter to control power output.

The clipping power of the power amplifier is its maximum peak output power. The power amplifier of AUDIOCENTER Artist Commercial Audio System Solution can output enough power to drive the speaker at maximum peak output power. You can use a suitable limiter to control the output power so as to prevent the speaker from receiving excessive power.

Never drive the speaker with a signal close to the resonant frequency of the speaker. Even at moderate power, it will cause its acoustic damping to the lowest point. The frequency range can be determined according to the system characteristics of the speaker. You can use an attenuation filter when necessary.

Maintenance

Artist Power amplifier needs to occasionally clean the ventilation holes in the chassis but no need daily maintenance. The air inlet & outlet must be kept clean and smooth to ensure the normal ventilation and heat dissipation. If the power amplifier is used in a dusty or smoky environment, we need to clean the air inter & outlet every day and periodically blow off (with high-pressure airflow) any foreign objects that may penetrate the chassis.

Users will not need to make any internal adjustments to the power amplifier during its lifetime. There are no adjustments that require opening the power amplifier. Cover removal exposes the risk of shock, so for all services, please contact qualified service technicians authorized by AUDIOCENTER.

User Responsibility

There may be a potential danger to speakers and operators as the Artist power amplifier is too powerful. Users are required to carefully read the "Important Precautions" and follow the instructions of the user manual to ensure the correct installation, wiring and operation for the power amplifier. Many speakers will be damaged due to excessive power, especially the high power under the bridge mode. Read the "Protection for Speaker" section to make sure that you understand the continuous power and peak power limits of the speaker. AUDIOCENTER is not responsible for any damage to the speakers.

Introduction of Artist T2.4V Front & Rear Panel Function

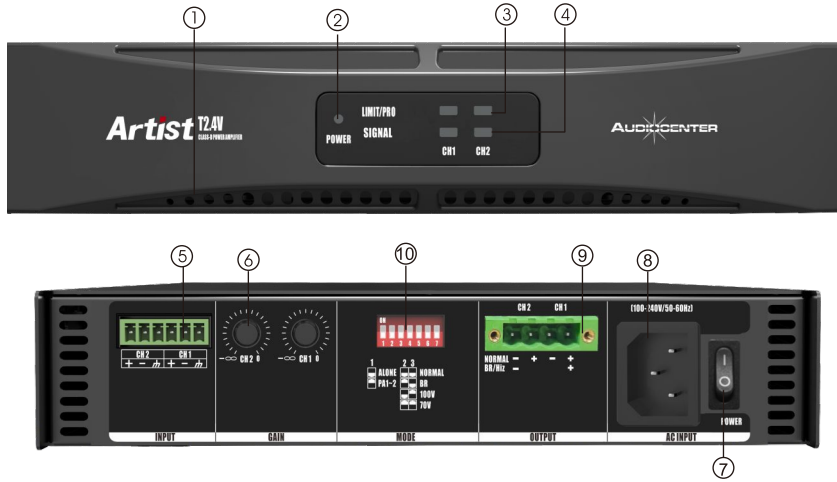

Introduction of Artist T4.4V Front & Rear Panel Function

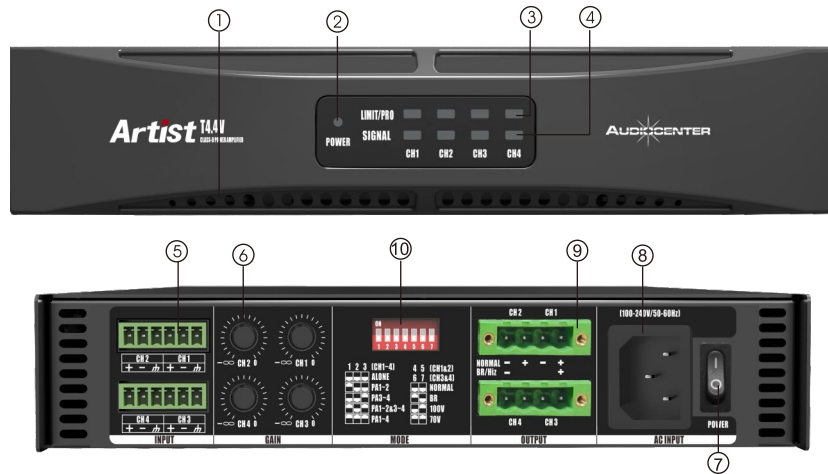

1. Air cooling window

This part is the air cooling window. Don't obstruct it.

2. Power LED

White light means working mode.
Red light means mute mode.

3. Limiter/Pro LED

Orange light means limit mode,
red light means protect mode.

4. Signal LED

Blue light means working mode.

5. Audio input

Euro-block connector, balanced input.

6. Potentiometer/Volume

Adjust the audio volume

7. AC Power switch

When the power amplifier is not in use, please
keep its AC power switch off.

8. AC power socket

9. Audio output

Euro-block connector, connected in Mono-channel
or bridge mode.

10. Mode selection switch





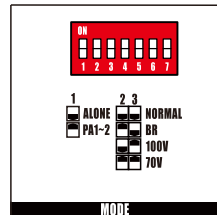

A set of DIP switches to configure the working
mode of the power amplifier.

Mode Selection

Artist T2.4V、Artist T4.4V mode selection switch, can set single channel, parallel, bridget,70v and 100v mode.



Artist T2.4V

	ALONE	Stereo channel mode means that the signal input and output are one-to-one correspondence (for example, the signal input from channel 1 and then output from channel 1, input from channel 2 and then output from channel 2)
	PA1-2	When DIP switch "1" is in the "ON" position, 1~2 channels are in parallel, signal input from channel 1, output from 1~2 channels at the same time.
	NORMAL	DIP switch "2" and "3" are used to set bridge mode and Hi Z mode. When they are in the "OFF" position, it indicates that no channel is set to bridge mode and Hi Z mode.
	BR	When DIP switch "2" is in the "ON" position, 1&2 are bridged into one channel, the signal is input from channel 1.
	100V	When DIP switch "3" is in the "ON" position, the output is 100V voltage output under Hi Z mode, which can drive 100V loudspeaker.
	70V	When DIP switch "2" and "3" is in the "ON" position, the output is 70V voltage output under Hi Z mode, which can drive 70V loudspeaker.

DIP switches "4", "5", "6" and "7" are reserved switches and are not used at present

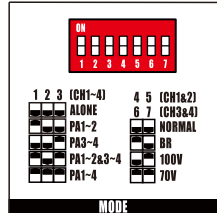

Artist T4.4V

	ALONE	Stereo channel mode means that the signal input and output are one-to-one correspondence (for example, the signal input from channel 1 and then output from channel 1, input from channel 2 and then output from channel 2)
	PA1-2	When DIP switch "1" is in the "ON" position, 1~2 channels are in parallel, signal input from channel 1, output from 1~2 channels at the same time.
	PA 3-4	When DIP switch "3" is in the "ON" position, 3~4 channels are in parallel, signal input from channel 3, output from 3~4 channels at the same time.
	PA1-2	When DIP switch "1" and "3" are in the "ON" position, 1~2 channels are in parallel, signal input from channel 1, output from 1~2 channels at same time; 3~4 channels in parallel, signal input from channel 3, output from 3~4 channels at same time.
	PA 3-4	
	PA1-4	When DIP switch "1", "2" and "3" are in the "ON" position, 1~4 channels are in parallel, signal input from channel 1, output from 1~4) channels at the same time.
	NORMAL	DIP switch "4" and "5" are used to set bridge mode and Hi Z mode for channel 1 and 2. When they are in the "OFF" position, it indicates that channel 1 and 2 are not set to bridge mode and Hi Z mode.
	BR	When DIP switch "4" is in the "ON" position, 1&2 are bridged into one channel, the signal is input from channel 1.
	100V	When DIP switch "5" is in the "ON" position, the output is 100V voltage output under Hi Z mode, 1&2 are bridged into one channel, which can drive 100V loudspeaker.
	70V	When DIP switch "4" and "5" is in the "ON" position, the output is 70V voltage output under Hi Z mode, 1&2 are bridged into one channel, which can drive 70V loudspeaker.
	NORMAL	DIP switch "6" and "7" are used to set bridge mode and Hi Z mode for channel 3 and 4. When they are in the "OFF" position, it indicates that channel 3 and 4 are not set to bridge mode and Hi Z mode.
	BR	When DIP switch "6" is in the "ON" position, 3&4 are bridged into one channel, the signal is input from channel 1.
	100V	When DIP switch "7" is in the "ON" position, the output is 100V voltage output under Hi Z mode, 3&4 are bridged into one channel, which can drive 100V loudspeaker.
	70V	When DIP switch "6" and "7" is in the "ON" position, the output is 70V voltage output under Hi Z mode, 3&4 are bridged into one channel, which can drive 70V loudspeaker.

Connection Mode

Input Connection

AUDIOCENTER recommends you to use the existing or professional balanced wires (with shielded wires), 22-24 AWG wires, and the Euroblock connectors supplied together with the speakerto connect with balanced input connectors of the amplifier (see the pictures below). You can also use unbalanced wires, but if the cables are too long, noise or radio frequency interference will occur.

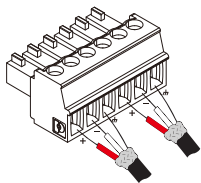

Balanced connection

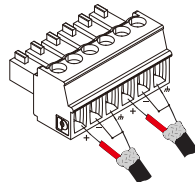

Unbalanced connection

Connected the (-) pole and ground wire using jumper wire

Output Connection

When the power amplifier is connected to a loudspeaker, it is recommended that you use the existing or professional, high-quality, twisted-pair and large-scale speaker cables.

Remember that the speaker cable resistance robs amplifier power in two ways: one is the power consumption directly caused by the resistance (that is, the I^2R loss we often say); the other is the increase of the entire load resistance, which reduces the Power delivered by the power amplifier

Audio output (low Z, bridge mode)

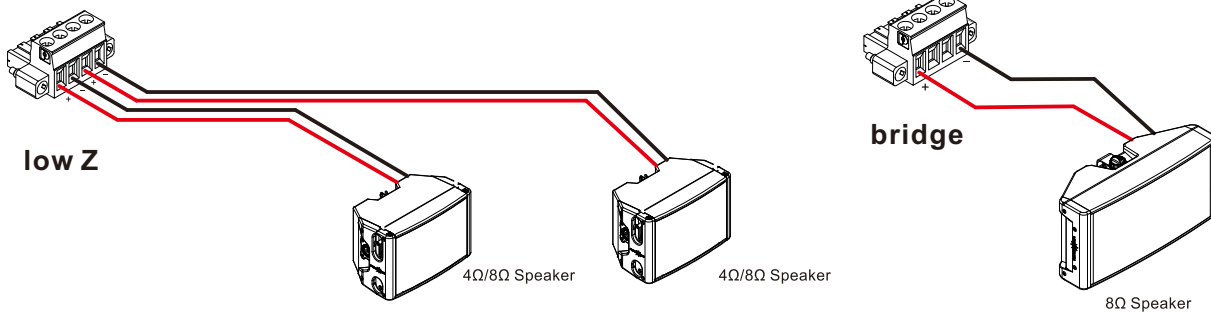

Audio output (Hi Z mode)



Note: the DIP switch need to be corresponding mode.

Note: the DIP switch need to be corresponding mode.

Front Panel

Artist T4800

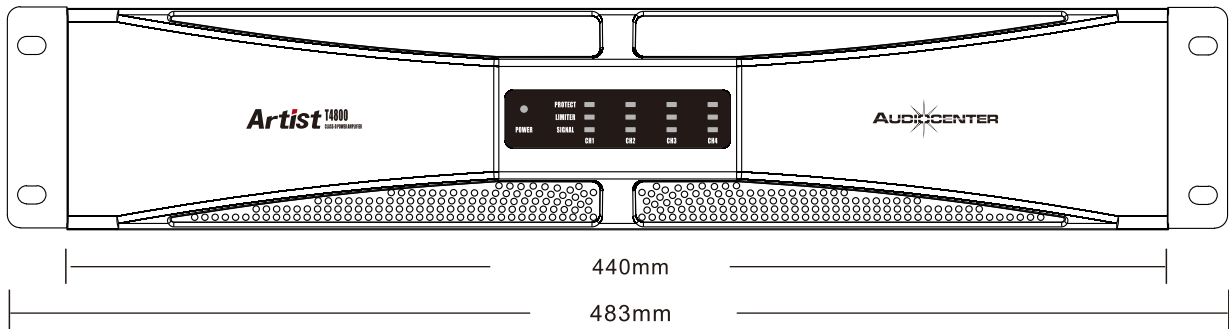

Artist T8800

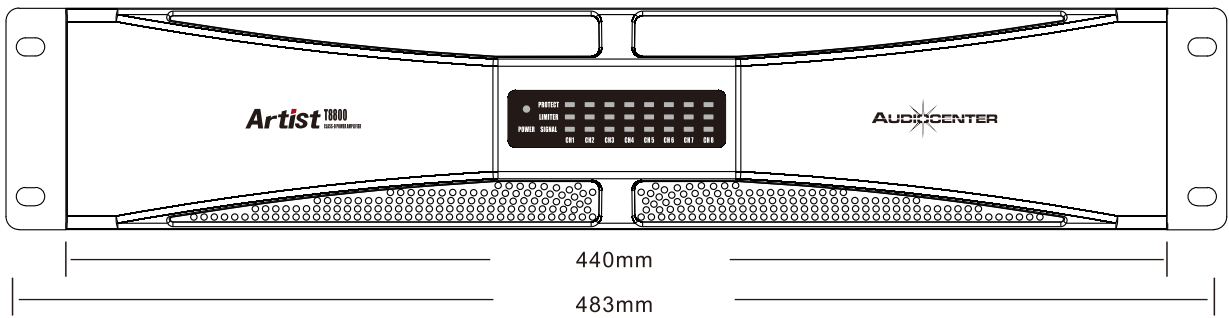

Rear & Side Panel

Artist T4800

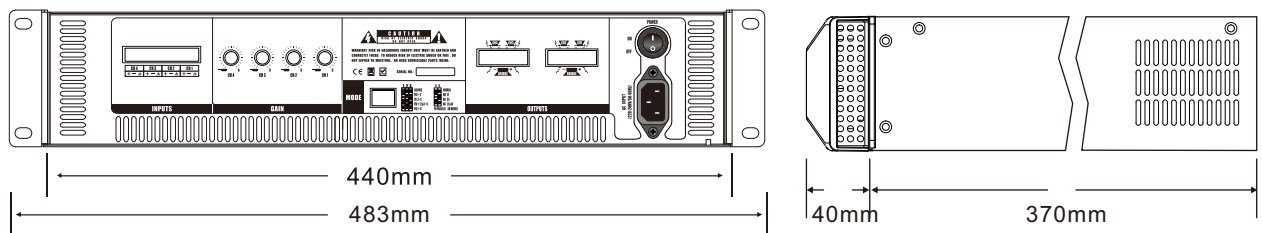

Artist T8800

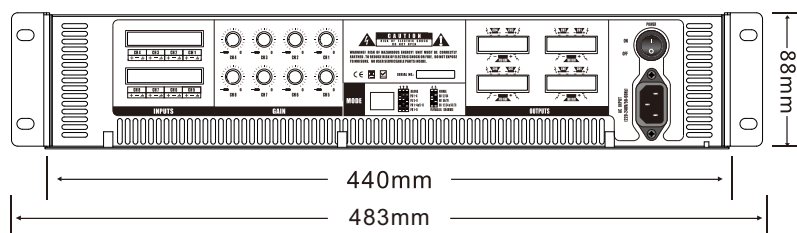

Introduction of Artist T4800 Front & Rear Panel Function

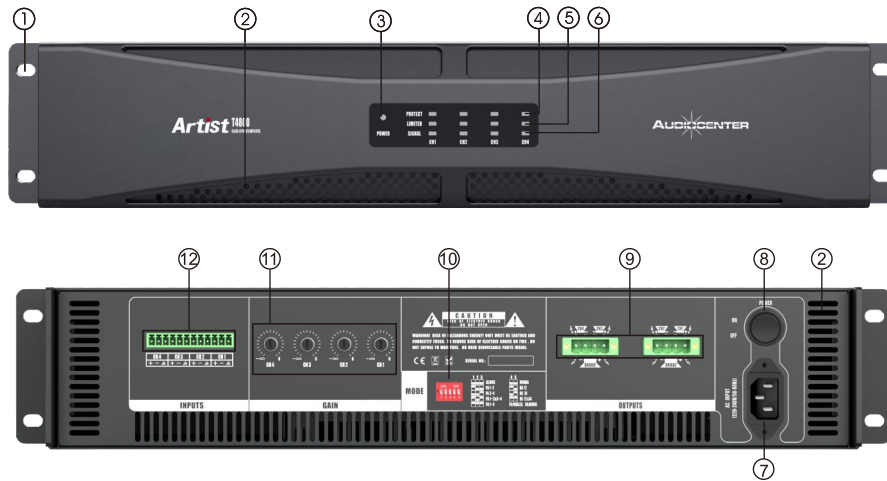

Introduction of Artist T8800 Front & Rear Panel Function

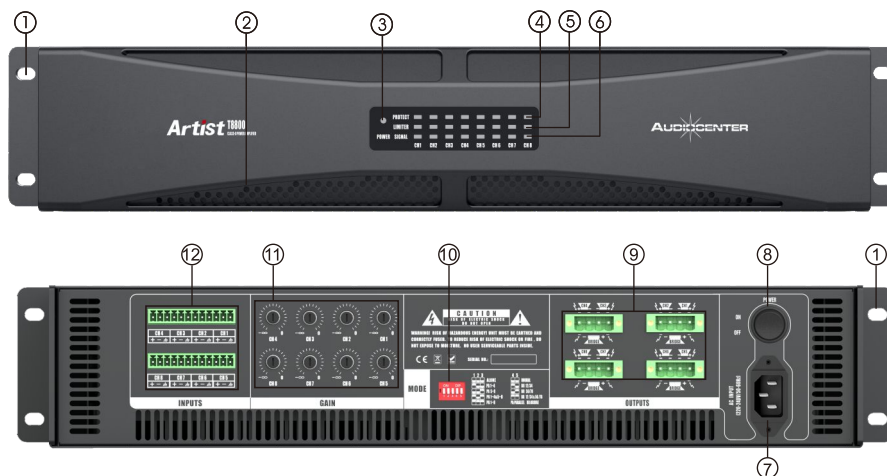

1. Mounting holes

There are two front panel mounting holes on each mounting ear.

2. Air cooling windows

This part is the air cooling window. Don't obstruct it.

3. Power LED

Power LED turns on (white) indicates that alternating current power is connected and amplifier turns on.

4. Protect LED

Protect LED turns on (red) indicates that channel is in protection mode.

5. Limiter LED

Limiter LED turns on (red) indicates that limiting protection circuit is running.

6. Signal LED

Signal LED turns on (blue) indicates that signal outputs from the power amplifier (above the minimum signal value).

7. AC power socket

8. AC power switch

When the power amplifier is not in use, please keep its AC power switch off.

9. Audio output

Euro-block connector, connected in Mono-channel or bridge mode.

10. Mode selection switch

A set of DIP switches to configure the working mode of the power amplifier.

11. Potentiometer/Volume

Potentiometer can be used to adjust the volume of amplifier.

12. Audio input

Euro-block connector, balanced input.

Mode Selection

The mode selection switch can be used to set the stereo, Parallel or Bridge mode. The factory default setting of the power amplifier is the stereo channel mode.

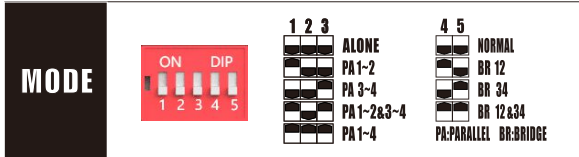

Artist T4800

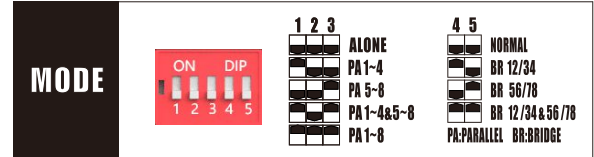

Artist T8800

	ALONE	Stereo channel mode means that the signal input and output are one-to-one correspondence (for example, the signal input from channel 1 and then output from channel 1, input from channel 2 and then output from channel 2)
	PA 1-2	When DIP switch "1" is in the "ON" position,(T4800 1~2)/(T8800 1~4) channels are in parallel, signal input from channel (T4800 1)/(T8800 1), output from(T4800 1~2)/(T8800 1~4) channels at the same time.
	PA 1-4	
	PA 3-4	When DIP switch "3" is in the "ON" position,(T4800 3~4)/(T8800 5~8) channels are in parallel, signal input from channel (T4800 3)/(T8800 5), output from(T4800 3~4)/(T8800 5~8) channels at the same time.
	PA 5-8	
	PA 1-2&3-4	When DIP switch "1" and "3" are in the "ON" position,(T4800 1~2)/(T8800 1~4) channels are in parallel, signal input from channel(T4800 1)/(T8800 1),output from(T4800 1~2)/(T8800 1~4)channels at same time;(T4800 3~4)/(T8800 5~8) channels in parallel,signal input from channel(T4800 3)/(T8800 5),output from(T4800 3~4)/(T8800 5~8) channels at same time.
	PA 1-4&5-8	
	PA 1-4	When DIP switch "1", "2"and "3" are in the "ON" position,(T4800 1~4)/(T8800 1~8) channels are in parallel, signal input from channel(T4800 1)/(T8800 1),output from(T4800 1~4)/(T8800 1~8) channels at the same time.
	PA 1-8	
	NORMAL	DIP switch "4" and "5" are used to set bridge mode.When they are in the "OFF" position,it indicates that no channel is set to bridge mode.
	BR 12	When DIP switch "4" is in the "ON" position,BR12(T4800)channel 1&2 are bridged into one channel(the signal is input from channel 1); BR12/34(T8800 1&2)/T8800-Pro 3&4) channels 1&2/channels 3&4 are bridged into one channel(the signal is input from channel 1(3).
	BR 12/34	
	BR 34	When DIP switch "5" is in the "ON" position,BR34(T4800)channel 3&4 are bridged into one channel(the signal is input from channel 3); BR56/78(T8800 5&6)/T8800 7&8) channels 5&6/channels 7&8 are bridged into one channel(the signal is input from channel 5/7).
	BR 56/78	
	BR 12 & 34	When DIP switch "4" and "5" are in the "ON" position,BR12 & 34(T4800 1~2)/(T4800 3~4)channels 1&2/channels 3&4 are bridged into one channel;BR12/34 & 56/78:(T8800 1~2)/(T8800 3~4)/(T8800 5~6)/ (T8800 7~8) channels 1&2/channel 3&4/channels 5&6/channels 7&8 are bridged into one channel.
	BR 12/34 & 56/78	

Connection Mode

Input Connection

AUDIOCENTER recommends you to use the existing or professional balanced wires (with shielded wires), 22-24 AWG wires, and the Euroblock connectors supplied together with the speaker to connect with balanced input connectors of the amplifier (see the pictures below). You can also use unbalanced wires, but if the cables are too long, noise or radio frequency interference will occur.

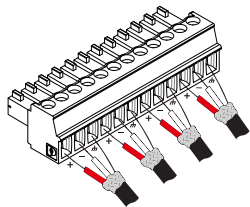

Balanced connection

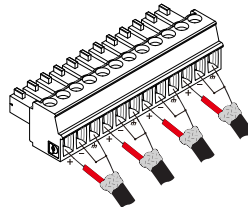

Unbalanced connection

Connected the (-) pole and ground wire using jumper wire

Output Connection

When the power amplifier is connected to a loudspeaker, it is recommended that you use the existing or professional, high-quality, twisted-pair and large-scale speaker cables.

Remember that the speaker cable resistance robs amplifier power in two ways: one is the power consumption directly caused by the resistance (that is, the I^2R loss we often say); the other is the increase of the entire load resistance, which reduces the Power delivered by the power amplifier

Artist T4800/T8800 Audio Output (Independent Mode)

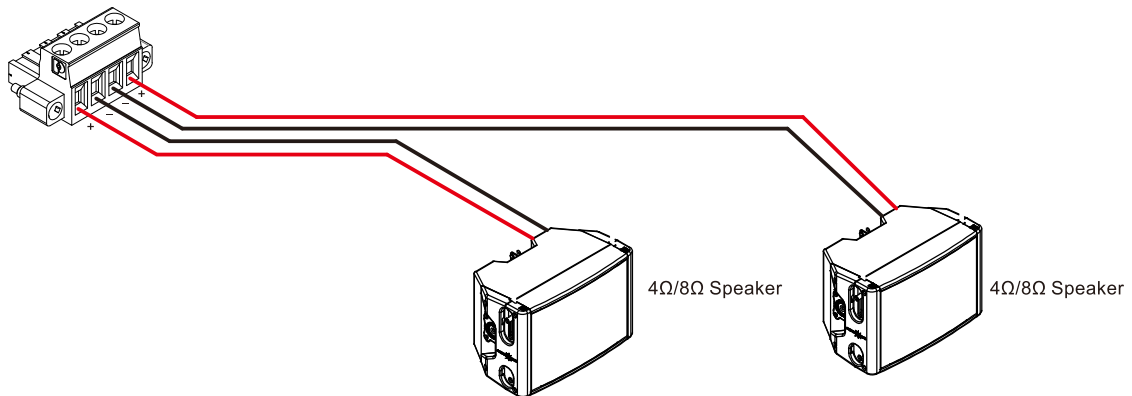

Artist T4800/T8800 Audio Output (Bridged)

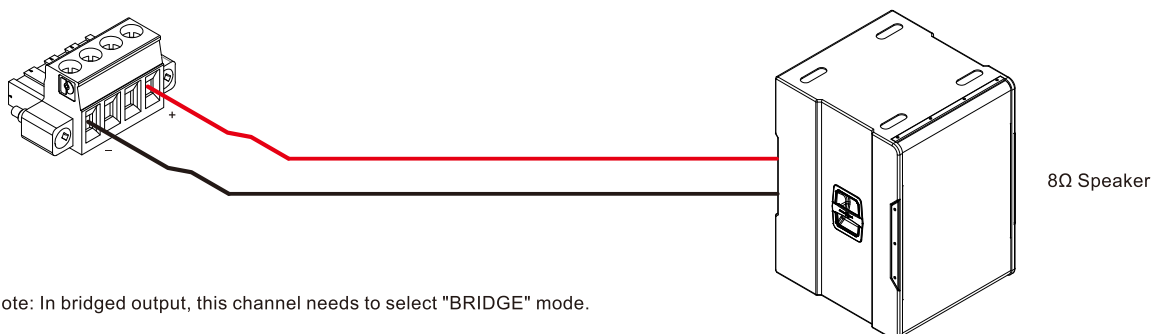

Note: In bridged output, this channel needs to select "BRIDGE" mode.

Front Panel

Artist T4.8V

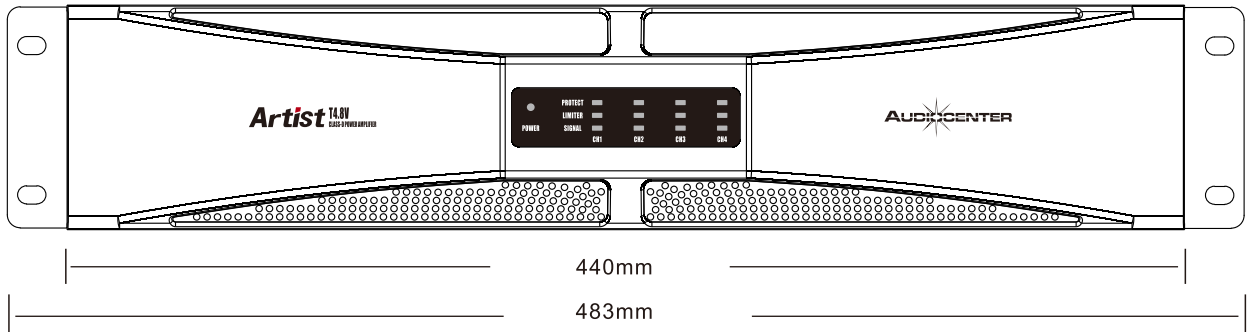

Artist T8.8V

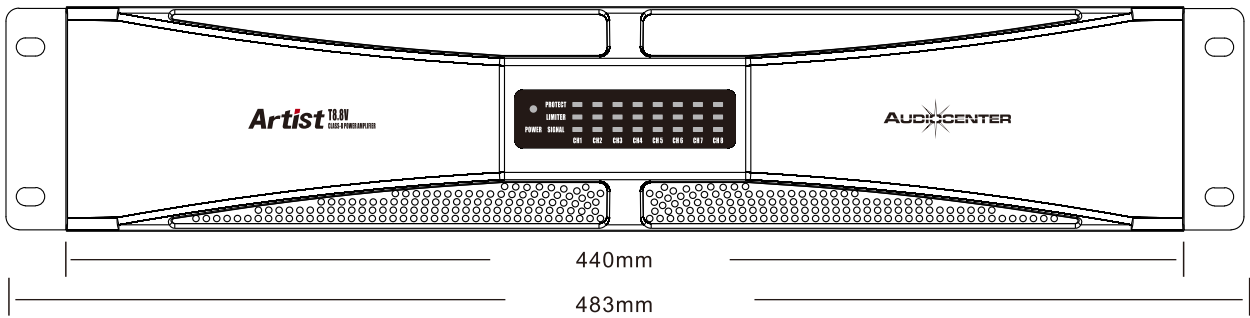

Rear & Side Panel

Artist T4.8V

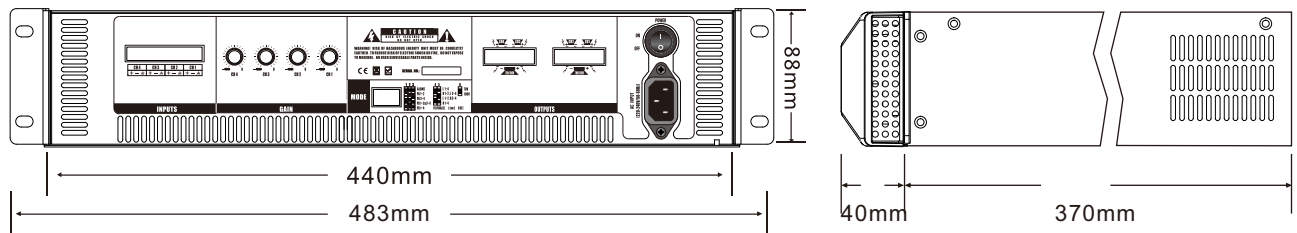

Artist T8.8V

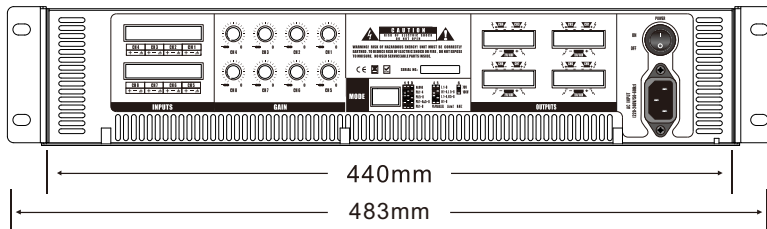

Introduction of Artist T4.8V Front & Rear Panel Function

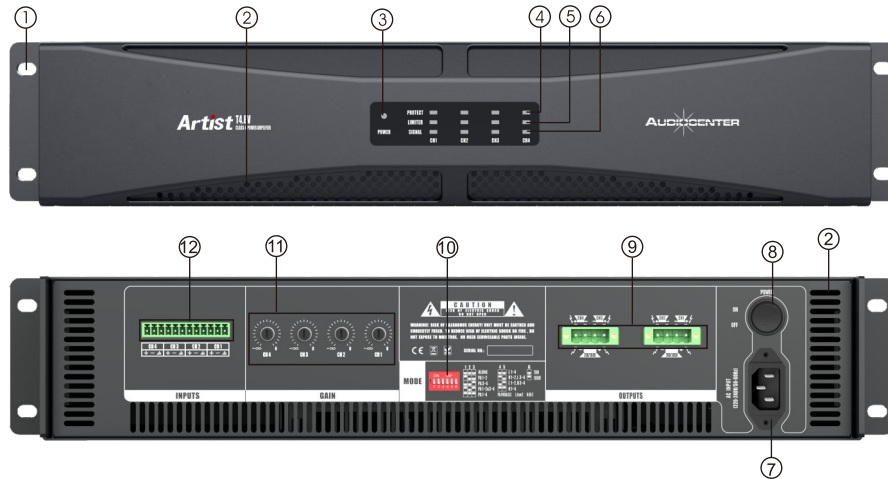

Introduction of Artist T8.8V Front & Rear Panel Function

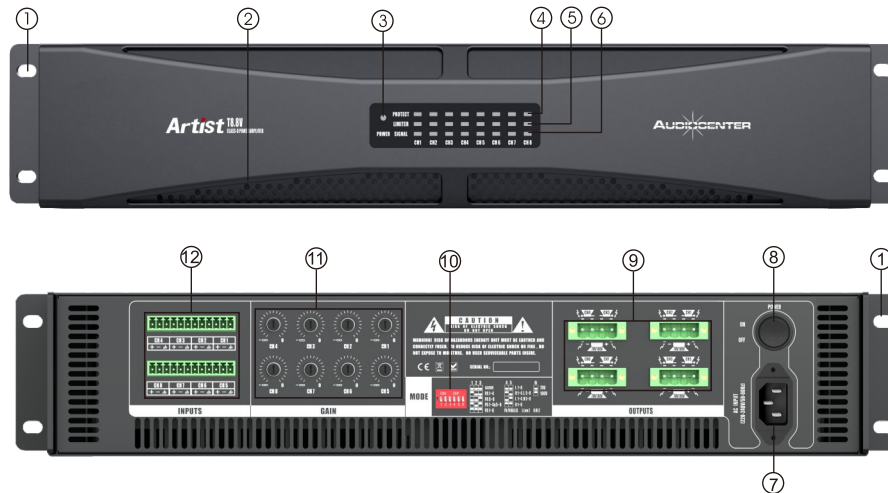

1. Mounting holes

There are two front panel mounting holes on each mounting ear.

2. Air cooling windows

This part is the air cooling window. Don't obstruct it.

3. Power LED

Power LED turns on (white) indicates that alternating current power is connected and amplifier turns on.

4. Protect LED

Protect LED turns on (red) indicates that channel is in protection mode.

5. Limiter LED

Limiter LED turns on (red) indicates that limiting protection circuit is running.

6. Signal LED

Signal LED turns on (blue) indicates that signal outputs from the power amplifier (above the minimum signal value).

7. AC power socket

8. AC power switch

When the power amplifier is not in use, please keep its AC power switch off.

9. Audio output

Euro-block connector, connected in Mono-channel or bridge mode.

10. Mode selection switch

A set of DIP switches to configure the working mode of the power amplifier.

11. Potentiometer/Volume

Potentiometer can be used to adjust the volume of amplifier.

12. Audio input

Euro-block connector, balanced input.

Mode Selection

The mode switch of Artist T4.8V and T8.8V can set for independent channel, Low Z or Hi Z mode. In Low Z mode, the output is independent for each channel. In Hi Z mode, users can choose 70V or 100V output to drive 70V / 100V loudspeaker.

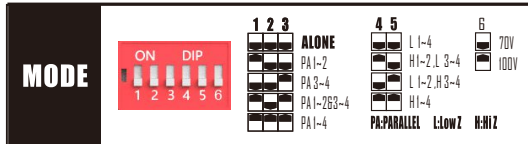

Artist T4.8V

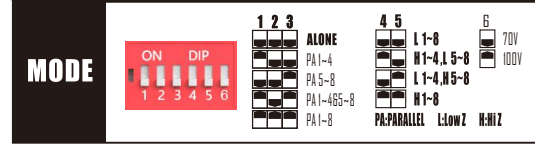

Artist T8.8V

	ALONE	Stereo mode indicates that the input and output signal are one-to-one corresponding. For example, signal is input from channel 1 and output from channel 1, input from channel 2 and output from channel 2.
	PA1-2	When DIP switch "1" is "ON", (T4.8V 1~2) / (T8.8V 1~4) channels are in parallel output, signal input from channel (T4.8V 1) / (T8.8V 1), output from (T4.8V 1~2) / (T8.8V 1~4) channels are the same. Input for T4.8V 3-4 (T8.8V 5-8) is independent.
	PA1-4	
	PA3-4	When DIP switch "3" is "ON", (T4.8V 3~4) / (T8.8V 5~8) channels are in parallel output, signal input from channel (T4.8V 3) / (T8.8V 5), output from (T4.8V 3~4) / (T8.8V 5~8) channels are the same. Input for T4.8V 1-2 (T8.8V 1-4) is independent.
	PA5-8	
	PA1-2&3-4	When DIP switch "1" and "3" are "ON", (T4.8V 1~2) / (T8.8V 1~4) channels are in parallel output, signal input from channel (T4.8V 1) / (T8.8V 1), output from (T4.8V 1~2) / (T8.8V 1~4) channels are the same; (T4.8V 3~4) / (T8.8V 5~8) channels are in parallel output, signal input from channel (T4.8V 3) / (T8.8V 5), output from (T4.8V 3~4) / (T8.8V 5~8) channels are the same.
	PA1-4&5-8	
	PA1-4	When DIP switch "1", "2" and "3" are "ON", (T4.8V 1~4) / (T8.8V 1~8) channels are in parallel, signal input from channel (T4.8V 1) / (T8.8V 1), output from (T4.8V 1~4) / (T8.8V 1~8) channels are the same.
	PA1-8	
	L1-4	When DIP switch "4" and "5" are "OFF", (T4.8V 1~4) / (T8.8V 1-8) channels are set as Low Z mode, which can drive 4Ω/8Ω loudspeaker.
	L1-8	
	H1-2, L3-4	When DIP switch "4" is "ON" and "5" is "OFF", H1 ~ 2, L3 ~ 4: (T4.8V 1~2) channels are set as voltage output, and (T4.8V 3~4) channels are set as impedance output; H1 ~ 4, L5 ~ 8: (T8.8V 1~2) / (T8.8V 3~4) channels are set as voltage output, and (T8.8V 5~8) channels set as impedance output;
	H1-4, L5-8	
	L1-2, H3-4	When DIP switch "4" is "OFF" and "5" is "ON", L1 ~ 2, H3 ~ 4: (T4.8V 1~2) channels are set as impedance output, and (T4.8V 3~4) channels are set as voltage output; L1 ~ 4, H5 ~ 8: (T8.8V 1~4) channels are set as impedance output, (T8.8V 5~6) / (T8.8V 7~8) channels are set as voltage output.
	L1-4, H5-8	
	H1-4	When DIP switch "4" and "5" are "ON", H1 ~ 4: (T4.8V 1~2) / (T4.8V 3~4) channels are bridged as voltage output; H1 ~ 8: (T8.8V 1~2) / (T8.8V 3~4) / (T8.8V 5~6) / (T8.8V 7~8) channels are bridged as voltage output.
	H1-8	
	70V	When DIP switch "6" is "OFF", the output is 70V voltage output under Hi Z mode, which can drive 70V loudspeaker.
	100V	When DIP switch "6" is "ON", the output is 100V voltage output under Hi Z mode, which can drive 100V loudspeaker.

Connection Mode

Input Connection

AUDIOCENTER recommends you to use the existing or professional balanced wires (with shielded wires), 22-24 AWG wires, and the Euroblock connectors supplied together with the speaker to connect with balanced input connectors of the amplifier (see the pictures below). You can also use unbalanced wires, but if the cables are too long, noise or radio frequency interference will occur.

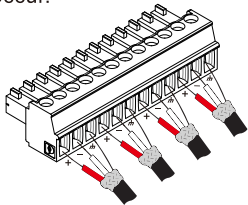

Balanced connection

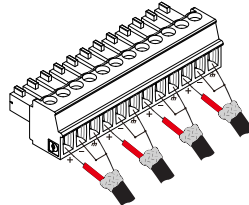

Unbalanced connection

Connected the (-) pole and ground wire using jumper wire

Output Connection

When connect the power a mplifier to a loudspeaker, it is recommended that you use the existing or professional, high-quality, twisted-pair and large-sized speaker cables.

Remember that the speaker cable resistance robs amplifier power in two ways: through power consumption directly caused by resistance (often referred to as I^2R loss), and through increased total load resistance, which decreases the amount of power available from the power amplifier.

Audio Output (constant impedance Low Z)

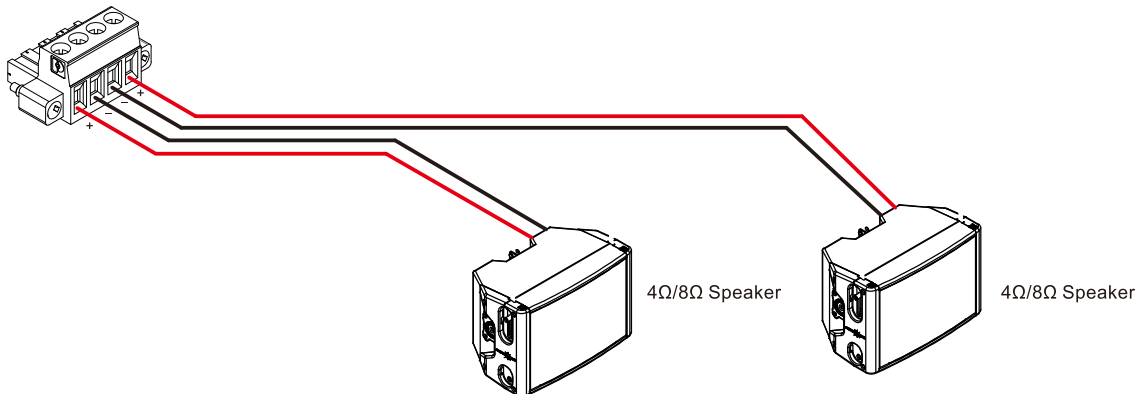

Audio Output (constant voltage Hi Z)

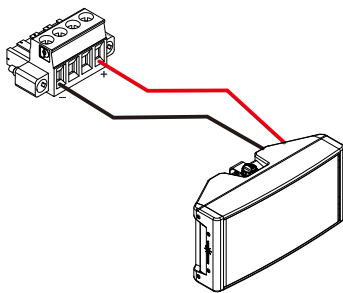

70V speaker system

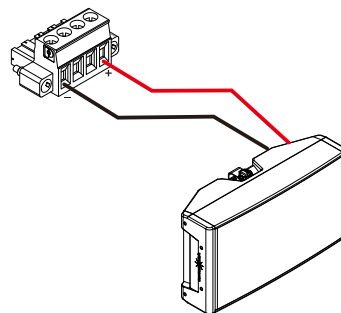

100V speaker system

Note: the corresponding channel mode switch should be configured as Hi Z mode, and 70V should be selected.

Note: the corresponding channel mode switch should be configured as Hi Z mode, and 100V should be selected.

Operation

Four conditions of Artist amplifier

- a. "idle"
- b. 1/8 power ("typical" music conditions);
- c. 1/3 power ("continuous" music conditions);
- d. Maximum rated power (sine wave signal).

Consult the specifications in the Appendices section for figures on the current that each power amplifier will demand. Make sure the mains voltage is correct and the same as that printed on the rear panel of the power amplifier. Damage caused by connecting the power amplifier to improper AC voltage is not covered by any warranty.

Power input

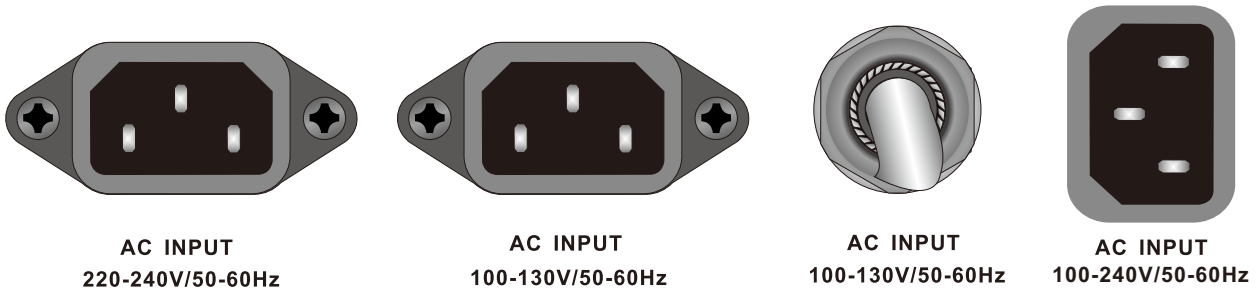

Note: Artist amplifier has three voltage 100-130V~/50-60Hz、220-240V~/50-60Hz、100-240V~/50-60Hz. Please use the corresponding amplifier according to local voltage.

Cooling system and requirements

Artist amplifiers use air cooling system to maintain a low and even operating temperature. Drawn in by fans installed inside, air flows through the heating elements, then exhausts through the rear panel slots. The intelligent variable speed fan is controlled by the temperature sensing circuits of the heat sinks. When the temperature of the detection point is higher than 45°C, the fan starts to operate, and then a large amount of air flow through the heating elements and takes away the heat, reducing the internal temperature, and making the power amplifier work stably for a long time.

IMPORTANT: To ensure optimum cooling, please make sure that there is enough space around the front and back of the power amplifier to allow the cooling air to escape. If the power amplifier is rack-mounted, allow at least one standard rack space at the front and back of the power amplifier.

Appendix A -Specifications



Specifications		Artist T2.4V	Artist T4.4V
Output Power (1kHz 20ms Burst THD+N=1%)	8Ω Stereo	2x130W	4x130W
	4Ω Stereo	2x260W	4x260W
	8Ω Bridge	1x520W	2x520W
	70V	1x520W	2x520W
	100V	1x520W	2x520W
Protection System		DC Protection, Short circuit protection, Overheat protection, Limiter Protection	
Working mode		Stereo, Parallel, Bridge, 70V/100V	
Frequency response(1W 8Ω 20Hz-20kHz)		±0.5dB	
Gain		Stereo:26dB; Bridge:32dB; 70V:34dB; 100V:37dB	
Maximum input voltage		15dBu	
Input Impedance		≥20kΩ (Balanced), ≥10kΩ (Unbalanced)	
Crosstalk		≤-70dB	
S/N Ratio		≥100dB	
Damping factor		≥200	
Intermodulation Distortion		≤0.05%	
THD+N		≤0.1%	
Power consumption	Sleep	3W	5W
	Idle	14W	27W
	1/8 output power	80W	160W
Amplifier Type (Output Circuitry)		Class D	
AC Power		100-240V/50-60Hz	
Connectors	Input	1x6-pin Euroblock (3.81mm)	2x6-pin Euroblock (3.81mm)
	Output	1x4-pin Euroblock (5.08mm)	2x4-pin Euroblock (5.08mm)
Rack space		1U design and half 19" rack space enclosure	
Dimensions(W×H×D)		218×44×314mm	218×44×314mm
Net weight		2.5kg	3.2kg

Artist



		Artist T4.8V	Artist T8.8V
Rated Power (20Hz-20kHz, <0.1%THD)	8Ω Mono	4x400W	8x400W
	4Ω Mono	4x800W	8x800W
	70V	2x800W	4x800W
	100V	2x1000W	4x1000W
Working mode		Mono, parallel, 70V/100V	
Frequency Response (1W 8Ω stereo)		20Hz-20kHz(±0.5dB)	
Sensitivity		32dB	
Input /Output Connectors		Euroblock	
Input Impedance		Balanced >10kΩ / Unbalanced >10kΩ	
Crosstalk (20Hz-20kHz, Rated power 8Ω)		≥60dB	
S/N Ratio (Rated power 8Ω, A weighted)		≥108dB	
Damping Factor (1kHz&8Ω)		≥500	
Intermodulation Distortion (20Hz-20kHz, half power)		≤0.05%	
Total Harmonic Distortion (20Hz-20kHz, half power)		≤0.05%	
Slew Rate		≥45V/μs	
Output circuitry		Class D	
Power consumption	Idle	39W	78W
	1/8 output power	350W	720W
Rack Space		2U	
Dimensions (W×H×D)		483x88x410mm	
Net Weight		8.5kg	11.5kg



		Artist T4800	Artist T8800
Rated Power (20Hz-20kHz, <0.1%THD)	8Ω Mono	4x400W	8x400W
	4Ω Mono	4x800W	8x800W
	8Ω Bridge	2x1600W	4x1600W
Working mode		Mono, parallel, bridge	
Frequency Response (1W 8Ω stereo)		20Hz-20kHz(±0.5dB)	
Sensitivity		32dB	
Input /Output Connectors		Euroblock	
Input Impedance		Balanced >10kΩ / Unbalanced >10kΩ	
Crosstalk (20Hz-20kHz, Rated power 8Ω)		≥60dB	
S/N Ratio (Rated power 8Ω, A weighted)		≥108dB	
Damping Factor (1kHz&8Ω)		≥500	
Intermodulation Distortion (20Hz-20kHz, half power)		≤0.05%	
Total Harmonic Distortion (20Hz-20kHz, half power)		≤0.05%	
Slew Rate		≥45V/μs	
Output circuitry		Class D	
Power consumption	Idle	39W	78W
	1/8 power	350W	720W
Rack Space		2U	
Dimensions (W×H×D)		483x88x410mm	
Net Weight		8.5kg	11.5kg



Dynamic Audio Solutions